

MILLIAMP CALIBRATOR MODEL 434

New Industry Standard!

- **Calibrate Loops With Laboratory Accuracy**
±(0.015% of Reading + 0.002 mA)
Accurate to 0.005 mA from 4 to 20 mA
- **All 4 to 20 mA Loop Functions**
Source and read milliamps
Simulate 2-Wire transmitters
Power transmitters while displaying transmitter output
Measure voltage from -100.0 to +100.0V DC
- **Full Range 1 microamp Resolution**
0.000 to 24.000 mA and -25.00 to 125.00% of 4 to 20 mA
- **Powers Loop or Transmitter**
Drives to 1200 Ohm loads – enough for any transmitter or loop
- **Standard “AA” Alkaline Batteries**
Over 30 hours of full 20 mA output. Auto-Off saves batteries.
- **User Settable “Quik-Chek® Switch”**
Store HI, SET & LO for instant recall
- **“Auto-Chek™” Output**
Automatically switches output in 2, 3, 5 or 10 steps
Automatic Ramp and Soak to simulate a process
- **“Valve-Chek®” Output**
Checks valve and actuator closing and opening
- **Digital Accuracy With Analog Simplicity**
Speed sensitive digital pot for fast output adjustment
- **HART Compatibility Option (Built-in)**



GENERAL INFORMATION

Calibrate Loop Instruments

Calibrate and troubleshoot all the signals in a standard 4 to 20 milliamp process control loop with Altek's new Model 434 Milliamp Calibrator. A 24 mA Source, mA meter, 2-Wire Transmitter Simulator and a DC Volt meter in one compact unit enables a single tool to perform most calibration and troubleshooting functions.

Source Milliamps

Calibrate controllers, recorders or other devices in 4 to 20 or 0 to 20 mA loops. Six “AA” batteries provide hours of continuous use. No need to leave the calibrator out of service to charge. Optional AC adapter for continuous use.

Simulate 2-Wire Transmitters

Check out the response of a loop by using the Model 434 in place of a 2-Wire transmitter. The Model 434 modulates the current passing through the loop just like a transmitter, but with manual control.

Power & Measure 2-Wire Transmitters

Simultaneously supply power to a 2-Wire transmitter while displaying the 4-20 mA output signal. The Model 434 supplies a nominal 24 Volts DC to the 2-Wire transmitter and shows the output current of the transmitter with 1 microamp resolution.

Read Voltage Outputs

Check 24 Volt loop supplies and batteries using the built-in voltmeter. Calibrate instruments with 1-5 Volt outputs.

Read Milliamp Outputs

Measure current anywhere in a loop. Check and adjust transmitter and controller outputs. Also measure current on transmitters with test jacks or across series diodes. Read milliamps with several times the accuracy of handheld DVMs.

QUIK-CHEK Switch

Save time with every calibration by using the advanced features of the Model 434. Instantly recall any three output settings with the handy QUIK-CHEK switch. All output settings are remembered, even with the power off.

Automatic Stepping & Ramping

Be in two places at once by using the Model 434's AUTO-CHEK. Connect behind the panel or replace a transmitter, then check the output in front of the panel or another remote location within the loop. Choose 2, 3, 5 or 10 output steps from 5 to 900 seconds to match your calibration setup.

Use the automatic Ramp/Soak to simulate a running process and check valves for smooth operation. Independently select your ramp time, soak time and endpoints for total flexibility.

Easily Check Valves & Actuators

Check valves and actuators with the built-in VALVE-CHEK function. Choose intervals from 5 to 900 seconds to repeatedly step up & down to check valves at and around the fully closed position and the fully open position. Or manually step through the points and use the knob for fine adjustment.



ALTEK INDUSTRIES CORP
A TRANSMATION COMPANY

35 Vantage Point Drive Rochester, New York 14624 U.S.A.
(716) 349-3500 • Fax (716) 349-3510

E-Mail: altekales@altekcalibrators.com • <http://www.altekcalibrators.com>

APPLICATIONS

Fast Milliamp Calibration

Calibrate the input of a recorder, computer, valve positioner or any other milliamp input device using the Model 434 to source milliamps or to simulate a 2-Wire transmitter. The source mode uses the batteries of the Model 434 to power the loop, or in 2-Wire Simulate mode, uses the power supply in the loop.

Store the milliamp values corresponding to the Span and Zero of the device being calibrated into the HI and LO Quik-Chek memories (typically 4.000 and 20.000 mA). Flip the Quik-Chek switch to the HI or LO position to recall the desired output. Turn the digital pot up and down and monitor the device being calibrated. Adjust the Span and Zero of the device being calibrated as required.

Calibrating a 2-Wire Transmitter in the Shop or Field

Simplify the calibration of 2-Wire Transmitters by using the Power Measure mode of the Model 434. In this mode, the Model 434 uses its internal batteries (or optional AC adapter) to provide the voltage to power up the 2-Wire Transmitter.

Connect a sensor or calibrator to the input of the transmitter and the Model 434 to the output of the transmitter. The display of the Model 434 will indicate the output of the transmitter in milliamps or percent, corresponding to the input signal provided by the sensor or calibrator connected to the input of the transmitter.

Save Time Obtaining “As Found” and “As Left” Data

To quickly obtain “As Found” and “As Left” calibration data, use the Model 434’s Auto-Chek to automatically output steps matching the input of the instrument being checked. Choose steps of 10, 25, 50 or 100% percent of range, corresponding to ten, five, three or two equally spaced steps to cover the range between the values stored in the HI and LO Quik-Chek memories. Select a moderate time period (10 to 30 seconds) to pause at each step to allow for settling time of the device being checked. Start the AUTO-CHEK from either end of the span by setting the Quik-Chek switch in the HI position, to go from the highest value down or in the LO position, to start from the lowest value up. Press the START/STOP push-button to start the AUTO-CHEK and press it again to stop it when you have recorded all the “As Found” data. Run it in both directions if you require data to check for hysteresis. Press the START/STOP push-button to stop the AUTO-CHEK and use the Quik-Chek switch to toggle between the HI and LO outputs to adjust the Zero and Span of the instrument being calibrated. Press the START/STOP push-button again to start the AUTO-CHEK and record the “As Left” data.

Locating Trip Points

The Model 434 can assist you in locating the setpoints on controllers or alarm points on current trips. The Auto-Ramp function smoothly increases and decreases the output of the 434 to simulate a running process.

Set the Auto-Ramp to cover the desired span for a moderate time period (60 seconds, for example). Start the ramp from either end of the span by setting the Quik-Chek switch in the HI position, to go from the highest value down or in the LO position, to start from the lowest value up. Press the START/STOP push-button to start the ramping and press it again to stop it when the trip point is indicated on the controller or current trip. The Model 434 will display the actual value reached when the button was pushed. You can now turn the digital pot up and down to go back and forth to precisely determine the trip and reset points.

Loop and Process Monitoring (Min/Max)

Automatically verify the control band of a controller or the variability of a process by using the Model 434 to monitor a milliamp signal. Set the Model 434 to read mA or % in series with

the loop to be monitored. Let the loop run under normal operating conditions and flip the Quik-Chek switch to MIN or MAX to instantly recall the lowest and highest values milliamp signals.

Note: be sure to disable the Auto-Off battery saver if you need to leave the Model 434 on for more than 30 minutes. Hint: flip the Quik-Switch switch up and down to restart the Auto-Off’s timer for another 30 minutes.

Simulating a Running Process

Simulate the ramp and soak or stabilizing time of an active loop with the easily settable Auto-Ramp of the Model 434. This operates in source mode using the batteries of the Model 434 to power the loop, or in 2-Wire Simulate mode if the loop has its own power supply. Select any span by storing the endpoints of the range to be simulated into the HI and LO Quik-Chek positions. Independently select the number of seconds for the duration of the ramp and the duration of the soak to approximate the running process. Press the START/STOP push-button to toggle the simulation on and off.

Checking for Fully Open & Fully Closed Valves

To check a valve & actuator for proper adjustment, you need to verify that it is fully open or closed with the proper input signal. Many control systems use a 4 to 20 mA signal to control the actuator. Checking fully open or closed requires supplying a milliamp signal that is slightly lower than the exact value, the exact value at fully open or closed, and a value slightly higher than the exact value. Check that there is no stem movement in the valve when the signal changes from out-of-range to the exact value and that the stem starts to move when the signal is slightly within range.

The Valve-Chek function of the Model 434 has three ranges designed to check the fully open & fully closed positions. The Valve-Chek HI cycles up and down through 19.800, 20.000 and 20.200 mA; the Valve-Chek LO cycles through 3.800, 4.000 and 4.200 mA; and the Valve-Chek SET cycles through 3.800, 4.000, 4.200, 12.000, 19.800, 20.000 and 20.200 mA.

Checking Valves for Smooth Operation

To check that a valve and actuator are operating smoothly, the valve and actuator must be slowly stroked (opened and closed) and monitored for rough spots or vibration. The vibration can be felt by hand, listened to by ear or through a stethoscope.

Set the Auto-Ramp function of the Model 434 to ramp for a number of seconds (from 5 to 900 seconds) approximating the operating opening and closing rate of the actuator. Some actuators and positioners have a slow response time that limits how quickly the valve can move. This prevents the valve from causing problems that arise up or down stream when the fluid flow rate changes too quickly. A few seconds of soak time is needed to give the valve and positioner time to come to a stop at each end of the ramp.

Press the START/STOP push-button to toggle the Auto-Ramp on and off. With the Auto-Ramp off, you can use the digital pot to manually stroke the valve to verify any rough spots.

Using the Model 434 as a Manual Loading Station

When you need to keep a stable process running and a controller or transmitter is going haywire, simply replace the malfunctioning instrument with the Altek Model 434. The 434 can be used to substitute for a transmitter signal and regulate the current in the loop or in place of a controller to supply the signal to drive the valve or other final control element.

Connect the Model 434 in place of the instrument being serviced while monitoring and adjusting the signal manually. When the faulty instrument is repaired, remove the 434 and bring the loop back on automatic control. Note: be sure to disable the Auto-Off battery saver if you need to leave the Model 434 on for more than 30 minutes.

OPERATING INSTRUCTIONS

General

Turn-On



Each time you turn on the Model 434 the LCD will display all segments for about 1 second. It then displays the most recently selected scaling for the function selected by the selector knob.



SOURCE - The three QUIK-CHEK outputs will be the same as previously stored. The same three QUIK-CHEKs are used for the SOURCE & 2 WIRE SIM functions.

READ - The 434 is ready to measure milliamps or DC Volts and is automatically updating the MAX & MIN readings for recall at any time.

Choosing Milliamp or Percent



You may choose to display from 0.000 to 24.000 mA or -25.00 to 125.00%. Press the MILLIAMP / PERCENT push-button to toggle the display. When scaled in percent, 100.00% corresponds to 20.000 mA and 0.00% corresponds to 4.000 mA.

Turn Off



Press the POWER push-button to turn the 434 off. If AUTO-OFF is enabled the 434 will turn itself off after 30 minutes of inactivity.

Autocal

CAL

To maintain accuracy, the Model 434 periodically recalibrates its measuring circuitry against internal references. While this is occurring the word CAL will appear on the display for less than 2 seconds.

Changing Batteries

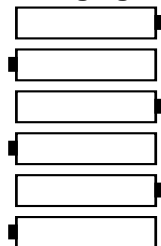

Low battery is indicated by BAT on the display. Approximately four hours of operation remain before the LCD blanks and Model 434 shuts itself down. Turn the 434 off, loosen the captive screw securing the battery compartment and lift off the cover from the bottom of the case. The six "AA" batteries are easily removed and replaced (alkaline supplied and recommended). Replace the battery compartment cover by inserting the tabs and tightening the screw.

User Options

Auto-Off

Model 434 can be set up to turn itself off after 30 minutes of inactivity. The internal timer is reset to 30 minutes each time a pushbutton is pressed. This configuration is part of the DEFAULT SETTINGS below.

Default Settings - User Options (Auto-Off)

The Model 434 may be restored to the factory settings. This will reset the HI and LO "QUIK-CHEK" memories to 20.000 mA and 4.000 mA and the SET memory to midrange (12.000 mA). Prompts guide you for selection of AUTO-OFF.

- 1) Press and hold the STORE/RESET push-button while turning the 434 on.
- 2) Keep pressing the STORE/RESET push-button until the display flashes (about 5 seconds) then release.
- 3) The words BAT and ON will appear on the display indicating that AUTO-OFF is selected.
- 4) To toggle the AUTO-OFF function on and off press the SETUP push-button and the words oN and oFF will display.
- 5) After five seconds the 434 will automatically store your choice and the 434 will begin normal operation. Or you may press the STORE/RESET push-button to accept your choice and begin operation.

HART Communicator Compatibility

An internal jumper enables the Power & Measure 2 Wire Transmitter mode to be compatible with HART communicators and transmitters. By removing this jumper a 250 Ohm resistor is placed in series with the output of the Model 434. This internal resistor eliminates the need to add an external load resistor when communicating with a HART transmitter (refer to diagram on page 7). This reduces the Typical Drive Capability to 950 Ohms.

Source & 2 Wire Functions

Select source by turning the selector knob to SOURCE MILLIAMPS or 2 WIRE SIM and the letters mA and SOURCE or mA, 2-WIRE SIM and SOURCE will appear on the LCD display. If percent 4-20 was selected the last time the 434 was used the indicator % will also appear and the display will be scaled in percent. To change the output value, turn the speed sensitive digital pot. Turning the knob slowly will cause a gradual change in the output. A faster rate of change will occur when the knob is turned faster. This function operates in all three output positions (HI, SET & LO).

Storing QUIK-CHEK Outputs

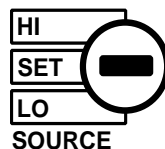

- 1) Switch to HI or LO
- 2) Turn the knob to desired value
- 3) Press the STORE push-button

The LCD will flash once to show that the value was saved

If a value is in the SET position and you want that value stored in HI or LO, press and hold the STORE push-button while moving the switch to HI or LO. The display will flash once to indicate the value has been stored. Then release the STORE push-button.



Recalling QUIK-CHEK Outputs

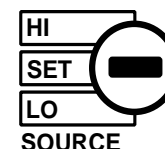

When you need a stored value just flip the QUIK-CHEK switch. Any value for the selected range may be stored in HI & LO. The Model 434 remembers the HI, LO and SET values with the power on or off.

Note: The same value is stored for both mA and %. The recalled value will be displayed in the units you have selected.

Open Loops

The digits on the LCD will flash if there is an open loop. The word POLARITY will appear on the LCD if the polarity is reversed in 2-Wire SIM and Read Transmitter Test Jack modes. Check all the connections in the loop or try reversing the leads.

Read Functions

Select read by turning the selector knob to mA READ OR VDC READ and the letters mA and READ or V and READ will appear on the LCD display. If percent 4-20 was selected the last time the 434 was used the indicator % will also appear and the display will be scaled in percent. There are two modes for mA READ. The first mode has fuseless protection to 120V AC/DC and is used to read the current flowing through a loop or when measuring the output of a controller. The second mode has a fuse for protection and is used to measure the current on transmitter test jacks or across a diode in series with the loop.

MIN/MAX

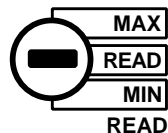

To read the Maximum or Minimum INPUT since READ mode was entered, simply switch to MAX or MIN. The value will appear on the LCD along with the word MAX or MIN. The MAX/MIN values are automatically updated and may be viewed at any time without disturbing the other values.

Restarting MIN/MAX



Pressing the STORE/RESET push-button will cause the Model 434 to store the present reading into the MAX and MIN memories. Upon releasing the STORE/RESET push-button the 434 will resume reading the input and update the MAX & MIN values as the measured signal changes.

Out of Range Signals



Signals above or below those available for the currently selected range will be indicated by Or and Ur on the display. The word POLARITY will appear on the LCD if the polarity is reversed in Read Transmitter Test Jack mode.

OPERATING INSTRUCTIONS

Source Milliamps

mA, mA % (Percent of 4 to 20 mA)

Choose this function to provide an output from 0.000 to 24.000 milliamps. The compliance voltage is a nominal 24 VDC to provide the driving power to your milliamp receivers or to drive a whole loop.

- 1) Disconnect one or both input wires from the device to be calibrated.
- 2) Press the POWER push-button to turn the Model 434 on and turn the selector knob to SOURCE MILLIAMPS.
- 3) Connect the red SOURCE lead of the calibrator to the plus (+) input of the device and the black SOURCE lead to the minus (-).
- 4) Press the MILLIAMP/PERCENT push-button to toggle the display between indicating 0.000 to 24.000 mA and -25.00 to 125.00% of 4 to 20 mA. The words SOURCE and mA or SOURCE, mA and % are displayed.

Continuously adjust the output by turning the speed sensitive digital pot. Zero & Span (or any other values) are available by using the LO and HI "QUIK-CHEKS" to recall your stored settings (4.000 & 20.000 mA defaults).

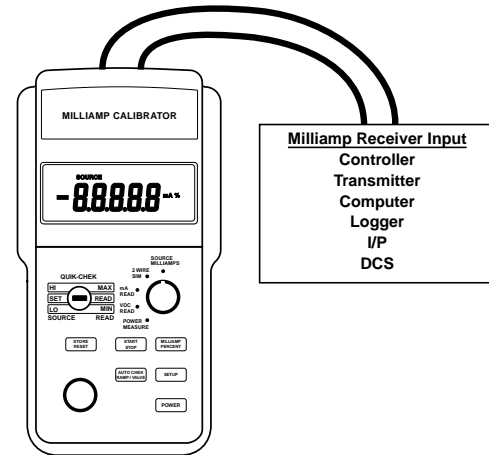

Simulate 2 Wire Transmitters

2-WIRE SIM mA, 2-WIRE SIM % (Percent of 4 to 20 mA)

Choose this function to simulate a 2-Wire Transmitter output from 1.00 to 24.00 milliamps. Operates in loops with power supply voltages from 3 to 45 VDC.

- 1) Disconnect existing 2-Wire Transmitter from the loop
- 2) Press the POWER push-button to turn the Model 434 on and turn the selector knob to 2 WIRE SIM.
- 3) Connect the red SOURCE lead of the calibrator to the plus (+) input of the field connections and the black SOURCE lead to the minus (-)
- 4) Press the MILLIAMP/PERCENT push-button to toggle the display between indicating 0.000 to 24.000 mA and -25.00 to 125.00% of 4 to 20 mA. The words SOURCE, 2-WIRE SIM and mA or SOURCE, 2-WIRE SIM, mA and % are displayed.

Continuously adjust the output by turning the speed sensitive digital pot. Zero & Span (or any other values) are available by using the LO and HI "QUIK-CHEKS" to recall your stored settings (4.000 & 20.000 mA defaults).

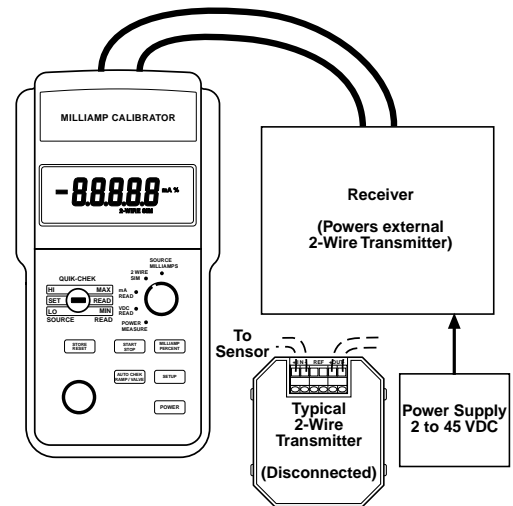

Power & Measure 2 Wire Transmitters

PWR XMTR mA, PWR XMTR %

Choose this function to simultaneously supply power to a 2-Wire transmitter while displaying the 4-20 mA output of the transmitter.

- 1) Disconnect one or both input wires from the 2-Wire Transmitter to be calibrated.
- 2) Press the POWER push-button to turn the Model 434 on and turn the selector knob to POWER MEASURE.
- 3) Connect the red SOURCE lead of the calibrator to the plus (+) input of the device and the black SOURCE lead to the minus (-).
- 4) Connect an appropriate sensor or calibrator to the input of the 2-Wire Transmitter.
- 5) Press the MILLIAMP/PERCENT push-button to toggle the display between indicating 0.000 to 24.000 mA and -25.00 to 125.00% of 4 to 20 mA. The words SOURCE, PWR XMTR and mA or SOURCE, PWR XMTR, mA and % are displayed.

The Model 434 supplies a nominal 24 Volts DC at 24 mA to power the 2-Wire transmitter. The current passed by the transmitter will be accurately displayed by the 434. Calibrate the Transmitter in the usual manner and disconnect the 434.

HART COMMUNICATOR COMPATIBILITY

An internal jumper enables the Power & Measure 2 Wire Transmitter mode to be compatible with HART communicators and transmitters. This eliminates the need to add an external load resistor when communicating with a HART transmitter (refer to diagram on page 7).

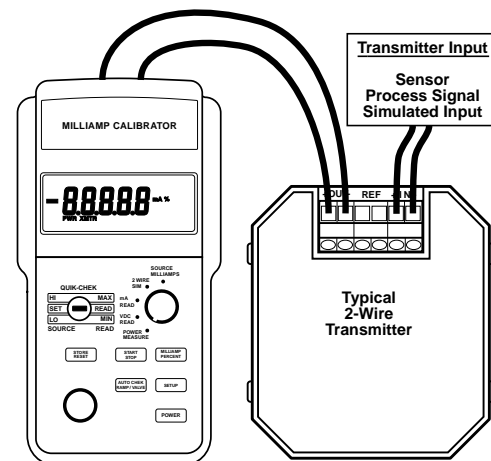

OPERATING INSTRUCTIONS

Read Milliamps

mA, mA % (Percent of 4 to 20 mA)

Choose this function to measure loop current or controller outputs from 0.000 to 24.000 milliamps or -25.00 to 125.00%. The standard read milliamps function has built-in fuseless protection to 120V AC/DC. This protects the Model 434 against accidental misconnection when using it on field connections, behind panels or on terminals on the back of instruments.

- 1) Open the current loop at any convenient point along the signal path
- 2) Press the POWER push-button to turn the Model 434 on and turn the selector knob to READ MILLIAMPS.
- 3) If the diode symbol ∇ appears on the display press the SETUP push-button and only READ and mA or READ, mA and % are displayed.
- 4) Press the MILLIAMP/PERCENT push-button to toggle the display between indicating 0.000 to 24.000 mA and -25.00 to 125.00% of 4 to 20 mA. The words READ and mA or READ, mA and % are displayed.
- 5) Connect the red (+) lead of the calibrator to the more positive point of the break and the black (-) lead to the more negative.

Display the present reading, Maximum or Minimum by moving the toggle switch from READ to MAX or MIN. If the Model 434 is connected in the wrong polarity, the word POLARITY will appear in the display. Simply reverse the leads for correct indication.

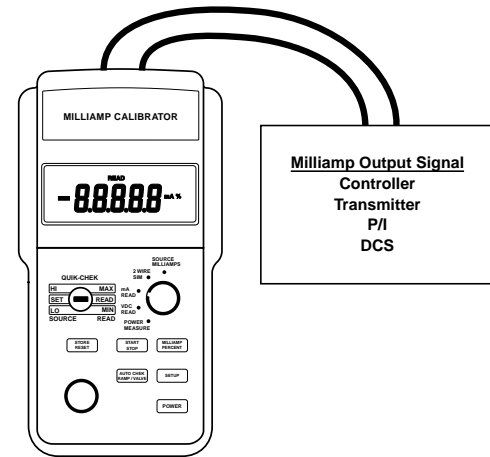

Read Transmitter Test Jacks or across Loop Diodes

mA, mA % (Percent of 4 to 20 mA)

Choose this function to measure loop current on transmitter test jacks or across diodes in series with the milliamp loop. Display from 0.000 to 24.000 milliamps or -25.00 to 125.00%. The read transmitter test jack function has a fuse for protection.

- 1) Press the POWER push-button to turn the Model 434 on and turn the selector knob to READ MILLIAMPS.
- 2) If the diode symbol doesn't appear press the SETUP push-button until The words READ, mA and the diode symbol ∇ or READ, mA, % and the diode symbol ∇ are displayed.
- 3) Press the MILLIAMP/PERCENT push-button to toggle the display between indicating 0.000 to 24.000 mA and -25.00 to 125.00% of 4 to 20 mA. The words READ, mA and the diode symbol ∇ or READ, mA, % and the diode symbol ∇ are displayed.
- 4) Connect the red (+) lead of the calibrator to the more positive point of the break and the black (-) lead to the more negative.

Display the present reading, Maximum or Minimum by moving the toggle switch from READ to MAX or MIN. If the Model 434 is connected in the wrong polarity, the word POLARITY will appear in the display. Simply reverse the leads for correct indication.

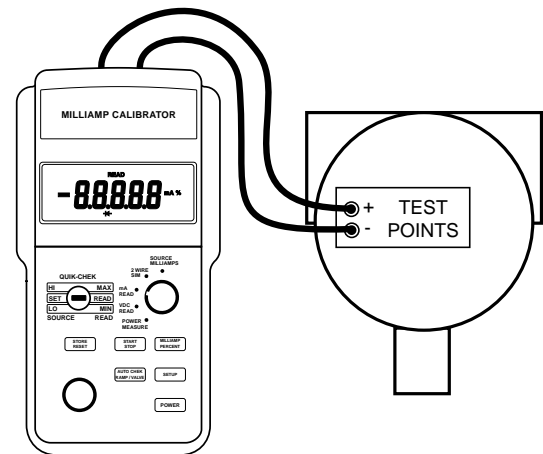

Read DC Volts

V DC

Choose this function to measure from -99.99 to +99.99 Volts DC to check batteries, loop power supplies or any process voltage output.

- 1) Press the POWER push-button to turn the Model 434 on and turn the selector knob to VDC READ.
- 2) Connect the red (+) lead of the calibrator to the positive point and the black (-) lead to the negative.

Display the present reading, Maximum or Minimum by moving the toggle switch from READ to MAX or MIN. If the Model 434 is connected in the wrong polarity, the word POLARITY will appear in the display. Simply reverse the leads for correct indication.

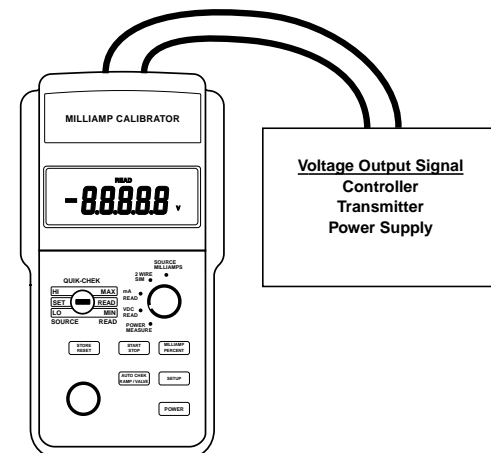

OPERATING INSTRUCTIONS

Automatic Functions

There are three automatic functions - Auto-Chek, Ramp & Valve-Chek. These automatic functions operate in the SOURCE MILLIAMPS and 2 WIRE SIM modes. Each automatic function is quickly selected and indicated on the LCD. All automatic operation are configurable and the configurations are remembered even when the power is off. Whenever an automatic function is selected, the previous configuration is recalled and the function will be indicated on the LCD. When no automatic functions are indicated on the LCD, all automatic functions are off.

Auto-Chek

The Model 434 can be set up to automatically or manually step the output with your choice of 2, 3, 5 or 10 steps from Zero to Full Scale. Select automatic steps from 5 to 900 seconds or select 0 seconds to manually select each of the 2, 3, 5 or 10 steps.

Ramp

Choose the ramp setting to repeatedly ramp between adjustable Zero and Full Scale. You select the ramp time from 5 to 900 and soak time from 0 to 900 seconds. The Model 434 will smoothly ramp the output and automatically hold steady at each end if you would like time to adjust the device being calibrated. The ramp can also be set up for a narrower span to simulate the ramping & soaking of a running process loop.

Valve-Chek

Check your valves and actuators for proper operation with automatic or manual steps. Fixed settings of 3.800, 4.000 and 4.200 mA check the low end of the actuator and fixed settings of 19.800, 20.000 and 20.200 mA check the high end. The Model 434 can also be setup to automatically or manually step through both high and low fixed settings with the addition of a midpoint at 12.000 mA.

USING AUTOMATIC FUNCTIONS

Auto-Chek

Setup

- 1) Select SOURCE MILLIAMPS or 2 WIRE SIM
- 2) Press the AUTO CHEK RAMP/VALVE push-button until AUTO-CHEK appears on the LCD.
- 3) Press the SETUP push-button and the words AUTO-CHEK, STEP and % appear on the LCD prompting you to enter the percent of span change between steps. Turn the knob until the correct percentage appears on the LCD. For 2 steps choose 100%, 3 steps choose 50%, 5 steps choose 25% and for 10 steps choose 10%. Press the SETUP push-button to continue.
- 4) The words AUTO-CHEK, STEP and SEC appear on the display prompting you to enter the number of seconds between steps. Turn the knob until the correct number of seconds per step (from 5 to 900) appears on the LCD. If you would like manual operation instead of automatic operation select 0 seconds per step. Press the SETUP push-button to complete the Auto-Chek setup.
- 5) Store the desired Full Scale & Zero into the HI & LO Quik-Chek positions.

Automatic Stepping (5 to 900 second per step)

- 1) Press the START/STOP push-button to automatically step the output up and down. The word STEP will flash on the LCD and the output will automatically step after the number of seconds selected in the setup have elapsed.
- 2) Press the START/STOP push-button to stop the automatic stepping. Press it again will restart.

Note: The Automatic stepping may be restarted at the HI or LO stored values based on the position of the Quik-Chek switch. The Auto-Chek will begin at the value stored in LO if the Quik-Chek switch is in the LO position or will begin at the value stored in HI if the Quik-Chek switch is in the HI position. The Auto-Chek will begin at the last automatic step if the Quik-Chek is in the SET position.

Manual Stepping (0 seconds per step)

Press the START/STOP push-button to manually step the output up and down. The output will step through the number of steps setup between the values stored in the HI & LO Quik-Chek positions each time you press the pushbutton. You may turn the knob at any time to precisely adjust the output, find a trip point or alarm, or stroke a valve.

Valve-Chek

Setup

- 1) Select SOURCE MILLIAMPS or 2 WIRE SIM
- 2) Press the AUTO CHEK RAMP/VALVE push-button until VALVE-CHEK appears on the LCD.
- 3) Press the SETUP push-button and the words VALVE-CHEK, STEP and SEC appear on the display prompting you to enter the number of seconds between steps. Turn the knob until the correct number of seconds per step (from 5 to 900) appears on the LCD. If you would like manual operation instead of automatic operation select 0 seconds per step. Press the SETUP push-button to complete the Auto-Chek setup.

Automatic Stepping (5 to 900 seconds per step)

- 1) Press the START/STOP push-button to automatically step the output up and down. The word STEP will flash on the LCD and the output will automatically step after the number of seconds selected in the setup have elapsed.
- 2) Press the START/STOP push-button to stop the automatic stepping. Press it again to restart.

Manual Operation (0 seconds per step)

Press the START/STOP push-button to manually step the output up and down. The output will step between the values in the Valve-Chek range selected by the position of the Quik-Chek switch each time you press the START/STOP push-button. You may turn the knob at any time to precisely adjust the output, find a trip point or alarm, or stroke a valve.

Note: Whenever Valve-Chek is activated the Quik-Chek HI & LO memories are reset to 20.000 and 4.000 mA.

Valve-Chek Ranges

Valve-Chek HI - Cycles up and down through 19.800, 20.000, 20.200 mA
Valve-Chek LO - Cycles up and down through 3.800, 4.000, 4.200 mA
Valve-Chek LO/HI - Cycles up and down among 3.800, 4.000, 4.200, 12.000, 19.800, 20.000, 20.200 mA

The selection of the Valve-Chek range is based on the position of the Quik-Chek switch. If the Quik-Chek switch is in the HI position the Valve-Chek HI range is selected, If the Quik-Chek switch is in the LO position the Valve-Chek LO range is selected and if the Quik-Chek switch is in the SET position the Valve-Chek LO/HI range is selected.

USING AUTOMATIC FUNCTIONS

Ramp

Setup

- 1) Select SOURCE MILLIAMPS or 2 WIRE SIM
- 2) Press the AUTO CHEK RAMP/VALVE push-button until RAMP appears on the LCD.
- 3) Press the SETUP push-button and the words AUTO-CHEK, RAMP and SEC appear on the display prompting you to enter the number of seconds between steps. Turn the knob until the correct number of seconds per ramp (from 5 to 900) appears on the LCD. Press the SETUP push-button to continue.
- 4) The words AUTO-CHEK, RAMP, SOAK and SEC appear on the display prompting you to enter the number of seconds to hold the output steady at the top and bottom of each ramp cycle. Turn the knob until the correct number of seconds to hold at each end (0 for no hold or from 1 to 900) appears on the LCD. Press the SETUP push-button to complete the Auto-Chek setup.
- 5) Store the required Span & Zero into the HI & LO Quik-Chek positions.

Automatic Operation

- 1) Press the START/STOP push-button to automatically ramp the output up and down. The word RAMP will flash on the LCD and the output will automatically ramp after the number of seconds selected in the setup have elapsed. The output will hold steady at the top and bottom of each ramp cycle for the number of seconds selected for the SOAK time. If the the soak time is set for 0 seconds the output will continuously ramp without holding at the top and bottom.
- 2) Press the START/STOP push-button to stop the automatic ramping. Press it again to restart.

Note: The Automatic ramp may be restarted at the HI or LO stored values based on the position of the Quik-Chek switch. The Auto-Chek will begin at the value stored in LO if the Quik-Chek switch is in the LO position or will begin at the value stored in HI if the Quik-Chek switch is in the HI position. The Auto-Chek will begin at the last value selected if the Quik-Chek is in the SET position.

RETURNING TO MANUAL OPERATION

Press the AUTO CHEK/AUTO VALVE push-button until no automatic modes are selected. This is indicated when none of the automatic modes (AUTO-CHEK, AUTO-VALVE or RAMP) are shown on the LCD.

OPERATING INSTRUCTIONS

HART Compatibility

An internal jumper enables the Power & Measure 2 Wire Transmitter mode to be compatible with HART communicators and transmitters. By removing this jumper a 250 Ohm resistor is placed in series with the output of the Model 434. This internal resistor eliminates the need to add an external load resistor when communicating with a HART transmitter (refer to diagram below). This reduces the Typical Drive Capability to 950 Ohms.

Fuse Replacement

If the Model 434 no longer measures current between transmitter test jacks or across a diode the internal fuse may have blown. Replace it with a fuse 5 x 20 mm and rated to 250 mA at 250V. Refer to the diagram below for location.

Accessing the Jumper & Fuse

- 1) Turn the 434 off
- 2) Loosen the screw on the battery cover. Remove the cover and batteries.
- 3) Remove the four remaining screws and carefully separate the enclosure.
- 4) Refer to the diagram for jumper location or fuse replacement.
- 5) Reverse the procedure for reassembly.

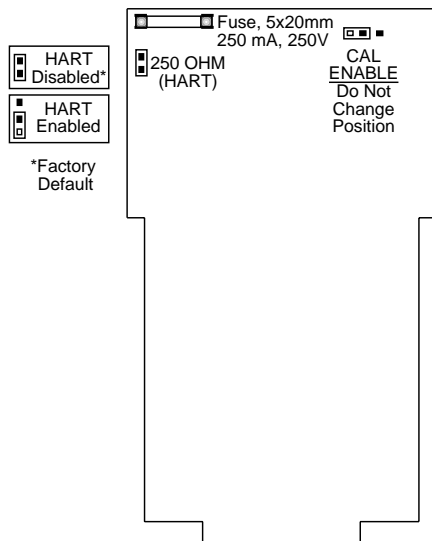

Tilt Stand and Carrying Case

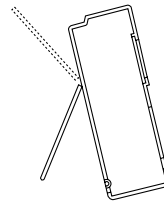

The Model 434 comes with a carrying case and a built-in tilt stand/hanger. The 434 is held securely in the case by VELCRO®.

The tilt stand is easily raised by pulling the stand until it locks into place. The stand can also be reversed for use as a hanger to suspend the Model 434.

SPECIFICATIONS

Model 434 Ranges & Accuracies

Milliamp Source, Power & Measure 2-Wire Transmitters, Read Milliamps, Read Transmitter Test Jacks. Simulate 2-Wire Transmitters operates from 1.000 to 24.000 mA.

Milliamp Functions	Low Limit	Hi Limit
24.000 mA	23.994 mA	24.006 mA
20.000	19.995	20.005
12.000	11.996	12.004
4.000	3.997	4.003
1.000	0.998	1.002
0.000	-0.002	0.002

Read DC Volts	Measure DC Volts	
	Low Limit	Hi Limit
100.0 V	99.5 V	100.5 V
50.0	49.5	50.5
25.0	24.5	25.5
5.0	4.5	5.5
0.0	-0.5	0.5

VELCRO® is a registered trademark of Velcro USA

SPECIFICATIONS

(Unless otherwise indicated, specifications are for 1 year in $\pm\%$ of Span @ 23°C)

General

Milliamp Accuracy: $\pm(0.015\%$ of Reading + 0.002 mA)
Temperature Effect: $\pm 0.008\%/^{\circ}\text{C}$ based on 23°C $\pm 25^{\circ}\text{C}$
Batteries: Six "AA" batteries (Alkaline supplied and recommended)
Battery Life:
Milliamp Source & 2-Wire Modes: Nominal 44 hours at 12 mA, 30 hours at 20 mA into 250 Ohm load
Other Functions: Nominal 75 hours
AC Adapters: Optional, 120 or 240 VAC, 50/60 Hz
Low Battery Indication: "BAT" indication on the display at 6.5 V nominal, approximately 4 hours left
Overvoltage Protection: Protected to 120 Volts AC or DC in all ranges (except fuse protected for Read Transmitter Test Jacks) without fuses for 30 seconds
Operating Temperature Range: -5 to +130°F (-20 to +55°C)
Storage Temperature Range: -13 to +130°F (-25 to +55°C)
Relative Humidity: 10 to 90%, non-condensing for 24 hours
Warm Up Time: 10 seconds to rated accuracy, 2 minutes to full accuracy
Overall Size: 6.23 x 3.27 x 1.94 inches (158.1 x 83.1 x 49.3 mm)
Weight: 1lb, 2oz (0.5 kg)

Milliamp Source

Ranges:
0.000 to 24.000mA with 1 microamp resolution
-25.00 to 125.00% of 4-20mA with 0.01% resolution
Typical Drive Capability: 1200 Ohms @ 20.000 mA
Power to Drive Receiver: Nominal 24 VDC
Compliance Voltage:
0 to 500 Ohm Load: 12 V nominal @ 20.000 mA
500 to 1200 Ohm load: 24 V nominal @ 20.000 mA

Power & Measure 2-Wire Transmitters

Ranges: Same as Milliamp Source
Output Current: up to 24.000 mA
Typical Drive Capability: 1200 Ohms @ 20.000 mA
Power to External 2-Wire Transmitter: Nominal 24 VDC

Read Milliamps

Ranges: Same as Milliamp Source
Voltage Burden: 0.9 V at 4 mA, 1.2 V at 20 mA, 1.4 V at 24 mA

Read Transmitter Test Jacks or across Loop Diodes

Ranges: Same as Milliamp Source
Overvoltage Protection: Fuse, 5 x 20 mm, 250 mA, 250 V
Input Impedance: 15 Ohms

Simulate 2-Wire Transmitters

Ranges: 1.000 to 24.000 mA
Loop Voltage Limits: Minimum, 2 VDC; Maximum 50 VDC

Measure DC Volts

Range: -100.0 to +100.0 DC Volts
Accuracy: $\pm 0.5\%$ of Full Scale Reading from 0.0 to 100.0V
Input Resistance: > 1 Meg Ohm
Source Resistance Effect: 0.01% per 100 Ohms

Specifications subject to change without notice

ADDITIONAL INFORMATION

THREE YEAR WARRANTY

Our equipment is guaranteed against defective material and workmanship (excluding batteries and leads) for a period of three years from date of shipment. Claims under guarantee can be made by returning the equipment prepaid to our factory. The equipment will be replaced, repaired or adjusted at our option. The liability of Altek is restricted to that given under our guarantee. No responsibility is accepted for damage, loss or other expense incurred through sale or use of our equipment. Under no conditions shall Altek be held liable for any special, incidental or consequential damage.

OTHER PRODUCTS

Altek designs and manufacturers fast, accurate instruments for measurement, generation and simulation of virtually every process control signal. Consult our factory directly or contact your local stocking representative to order precise, low cost Milliamp Calibrators, Voltage Sources, Thermocouple Sources, RTD Simulators, Frequency Calibrators and Pressure Pumps, Indicators & Calibrators. Altek also produces calibrators for custom ranges and unique applications. New models are frequently added to the Altek family to meet all of your critical calibration requirements. Altek products are made in the USA.

ORDERING INFORMATION

	Part No.
Milliamp Calibrator	434
Included with each Model 434 are:	
1 Pair of 1 meter (3') test leads with banana plugs and alligator clips (Wire Kit-8)	
Carrying Case 09-3782	
Data Sheet	
NIST Traceable Certificate and Three Year Warranty	

OPTIONAL ACCESSORIES

	Part No.
AC Adapter for 100 to 120 VAC	9V-0120
AC Adapter for 200 to 240 VAC	9V-0240
Replacement Leads	Wire Kit-8

AVAILABLE FROM